

Multifunction eddy current sorter

User's Manual

Nanjing BKN Automation System Co.,Ltd

➤ Description of this instrument:

The warranty period of this instrument is one year. During the warranty period, the instrument will be repaired free of charge if there is any quality problem. Charged maintenance will be implemented outside the warranty period. Users of this instrument can obtain the consulting service of the manufacturer for life. Please noted that the following conditions are not covered by the free warranty:

1. Mechanical damage occurred. Failures caused by falling, collision, and non-handling.
2. Failure or damage caused by self-reform, adjustment and maintenance.
3. Failure to perform external wiring as required, and circuit overload caused by input and output electrical specifications not meeting requirements.
4. Damage caused by force majeure factors such as natural disasters.
5. Guarantee to be effective all over the world.

➤ Precautions in use:

1. The power supply specifications for this instrument are:

Voltage :180~240 VAC

Frequency :50/60 Hz

Make sure the enclosure is reliable to connect the earth before the equipment is electrified.(Use a three-core power socket with secure grounding)

Failure caused by the use of power specifications other than the provisions is not covered by warranty.

2. The ambient temperature of the instrument is 0 °C ~ 40 °C, and the humidity is 10% ~ 85%
3. The grounding resistance of the instrument shell shall be less than 100 Ω
4. Do not open the enclosure when the instrument is powered on.
5. This instrument belongs to precision equipment, so it should be handled with care during moving and transportation. Special packing boxes shall be used during transportation.

➤ ➤ Summary:

The EC+ model computer hardness tester is a multi-functional, practical, high-performance/price-bit instrument. It integrates many years of experience in manufacturing eddy current hardness sorters to meet the needs of various users. It can be widely used to identify and classify the material composition, hardness, surface hardened layer depth, tensile

strength, heat treatment state, cracks, wrong teeth, and mixtures of various nonferrous metals, ferrous metals, rods, metal parts, etc. selected.

Use Windows Chinese operation interface, modular operation, provide multiple display modes for selection, and apply full digital design technology, no need to readjust the instrument when changing product production specifications, to achieve simple operation.

➤ Detection principles and composition:

The instrument passes an alternating current of a certain frequency through two detection coils, one of which is placed in a standard part, and when the test piece is placed in another coil, the hardness, conductivity and permeability of the test piece and the metallurgy and machinery of the test piece The defect will cause the impedance of the detection coil to change. The detection instrument amplifies and converts the electrical signal generated by the detection coil impedance to drive an alarm or display device, and finally detects samples with different hardness.

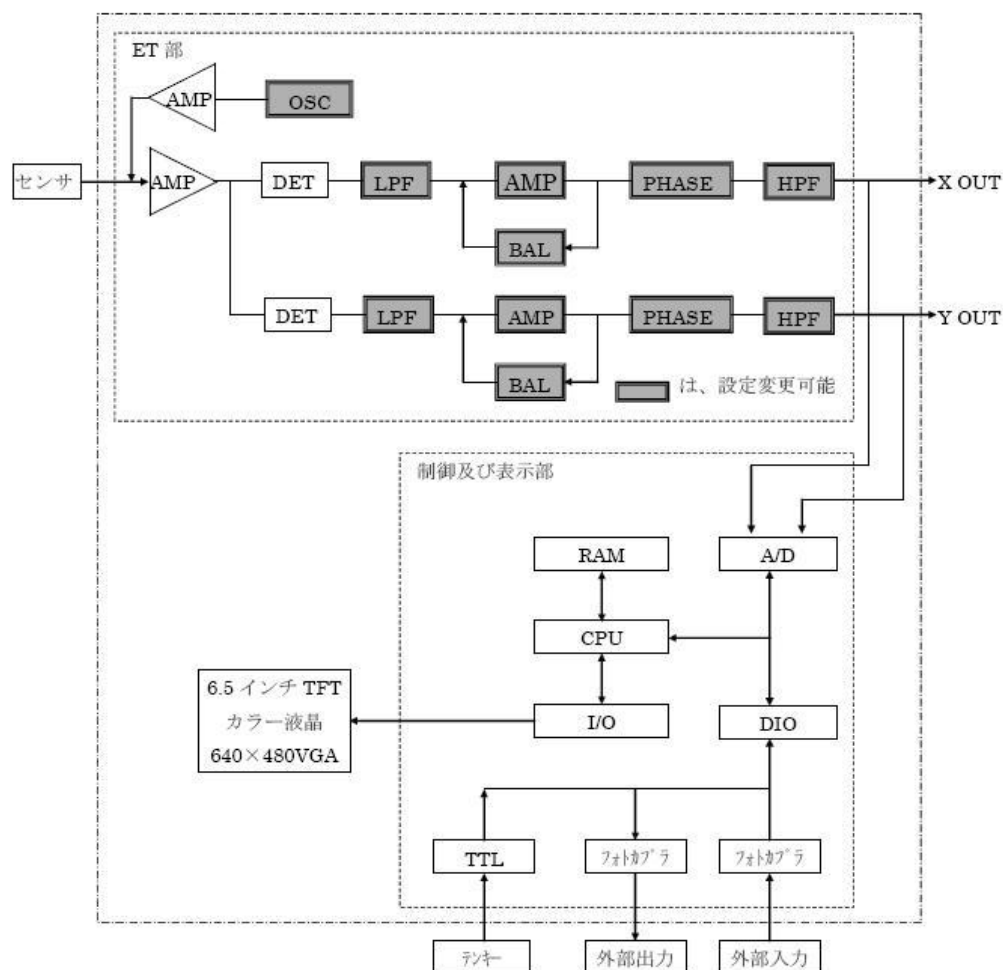

The oscillator generates an adjustable two-way sine wave with a frequency of 100 Hz to 1 MHz.

All the way to a wide frequency power amplifier as an excitation source to drive the probe, the probe constitutes the bridge arm of the AC bridge. When the probe detects the sample, the change in the physical properties of the sample changes the eddy current field induced by the excitation source on the sample. As a result, the original impedance (real component R and imaginary component X) of the probe changes, thereby destroying the original AC bridge. After the balance, the complex voltage U containing the detection signal is obtained. The signal is sent to the X and Y decomposers after being decomposed by the broadband preamplifier.

The circuit bridge balance circuit is used to cancel the unbalanced initial complex voltage U of the AC bridge. The oscillator outputs two orthogonal sine waves to the sampling pulse generator to generate mutually orthogonal sampling pulses for use by the X and Y resolvers. After the manual signal from the preamplifier is decomposed by sampling, the X and Y components of the probe are amplified by the filter amplifier and sent to the A/D interface circuit. The measurement signal is processed by the microcomputer system, the measurement result is directly displayed, and the control signal is output to achieve sound and light. Alarm, marking, automatic sorting, etc.

➤ **Key technical indicators:**

1. Instrument speed :1-5/second
2. Frequency range :0.2 K Hz~400 K Hz
3. Gain 23~69 dB, regulator 1 dB/ shift
4. High pass: set to 0 Hz
5. Low pass :10 Hz ~1000 Hz
6. Advanced filtering: available
7. Computer digital parameter adjustment
8. Real-time impedance plane display
9. Resolution :±3 HRC
10. High precision real time, alarm output
11. Multi-phase/amplitude alarm technology
12. Windows interface, modular man-machine dialogue
13. Power :180 V ~240 V 50Hz
14. Temperature :-20°C~+40°C
15. AC220V: power cord socket.
16. I/O socket: alarm output, marking output, synchronous input, etc., see wiring diagram for details. DC24V active output, can drive 500mA below current load. such as alarm lights, solenoid valves, etc.

17. Probe socket: connect detection probe, DB9 socket.

➤ Description of back panel of instrument host:

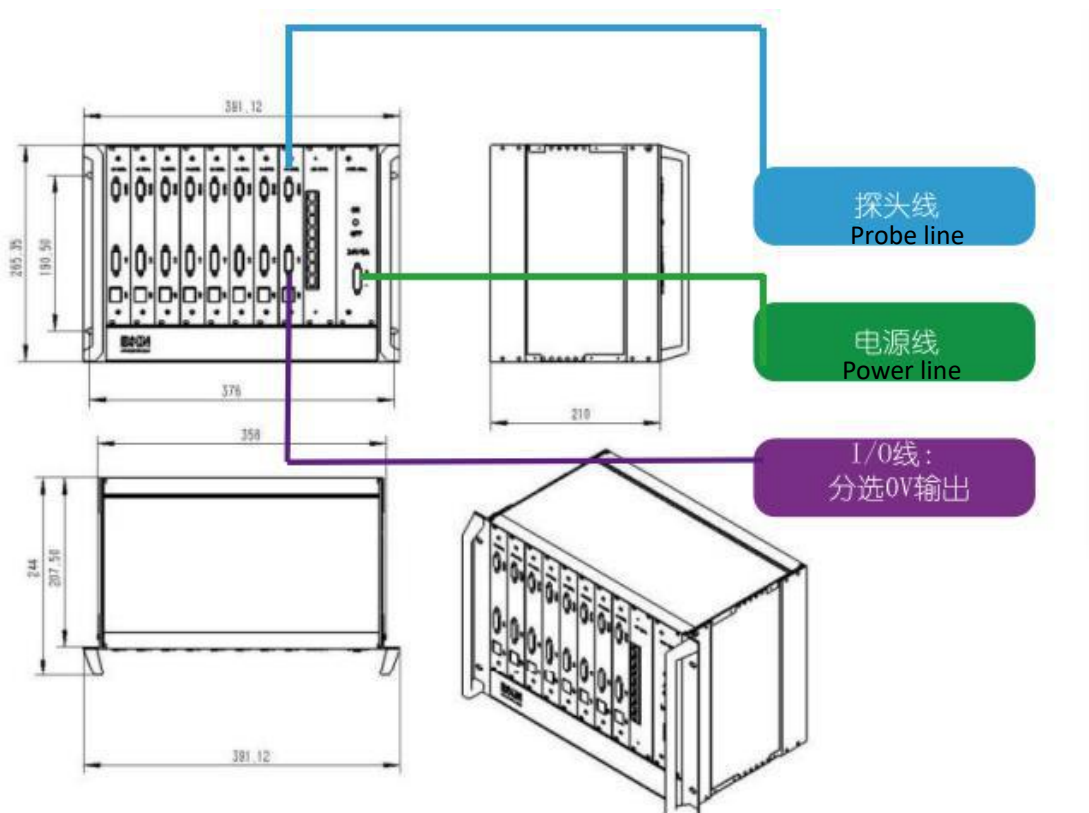

■ AC220V: power cord socket

■ I/O line socket: alarm output, sorting OK and NG signal output, see wiring diagram for details.

24V active output, can drive 500mA below current load (such as alarm lamp)

■ probe socket: connect detection probe, DB9 socket.

➤ **Interface operation before software operation:**

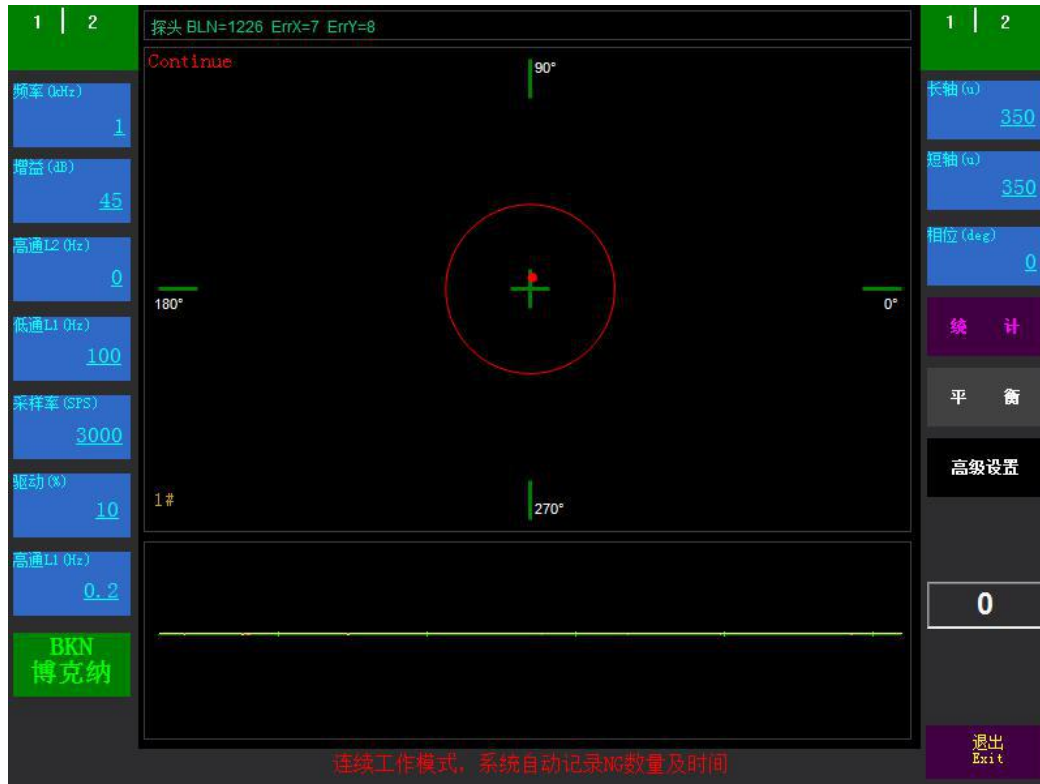

Note: After opening the software, select the right side of the interface



pop-up adjustment interface as follows:

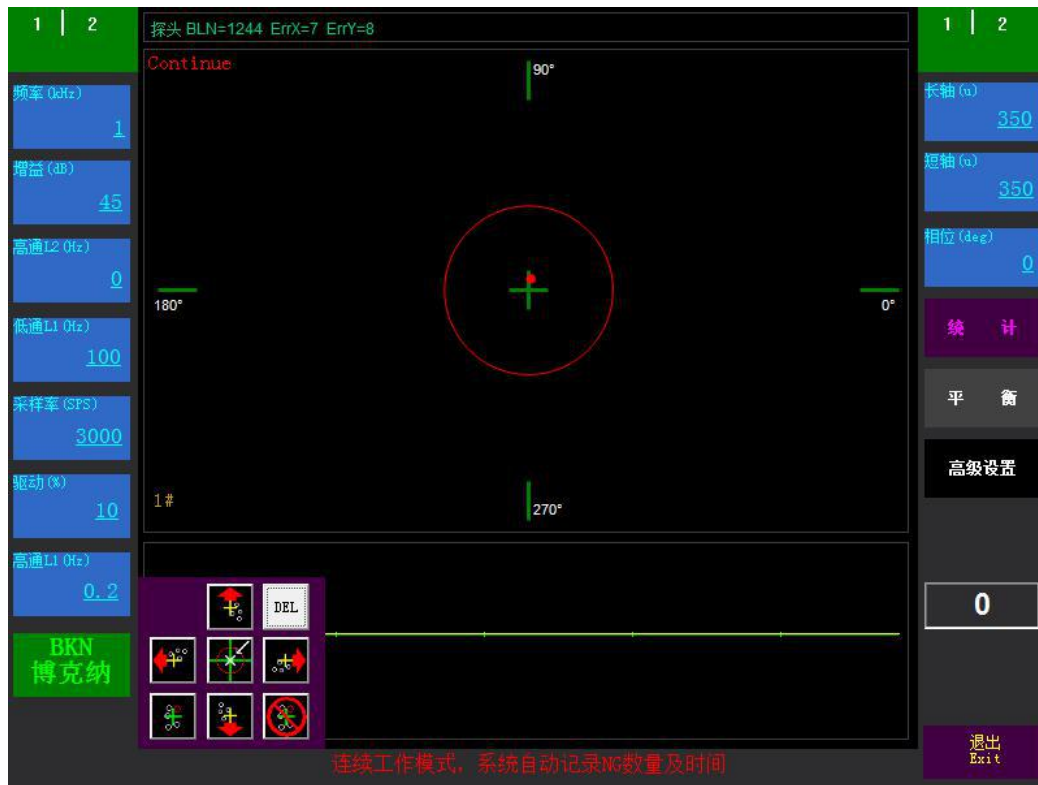

➤Parameter setting and description:

1. First page on left side of software interface

- 
 Frequency: the frequency of the eddy current excitation signal. Parameter adjustment range 100 Hz (0.1 k Hz)~1 MHz, Select the appropriate frequency according to probe model and workpiece (can consult technician)

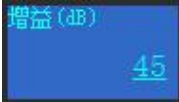
- 
 Gain: Number of decibels (dB) of signal amplification.

$$LgGain \text{ dB}=20^*$$

dB dB: gain

Multiple Gain: gain

Gain adjustment range 23-69, adjusted according to interface graphical sensitivity

- 
 High pass L2: signal filtering parameters. **Must be set to 0.**

低通L1 (Hz)
100

- Low pass L1: signal filtering parameters. unit is the unit of frequency Hz (number of variations per second). This parameter is mainly used to eliminate interference due to electrical environment, or other possible higher frequency interference. The smaller the parameter value, the better the effect of eliminating the interference, but it also suppresses the eddy current signal to some extent. Therefore, the principle of this signal value should be : " in the case of interference signal is not strong to take the larger value ." The parameter is to be lower than the frequency, adjusted according to experience.

Low pass L1 is generally set to 200.Adjustable 20-1000 Hz

采样率 (SPS)
3000

- Sampling rate: The sampling rate is the rate at which an input signal is measured.

Sampling rate 2000-10000. Reference value 3000-4000(The details are subject to sample tube)

驱动 (%)
10

- Drive (%): The current ratio of the excitation coil in the probe, with a maximum of 100. The larger the value, the greater the induced magnetic field.**Note: If the value is too large, the probe detection coil is not easy to balance**

Drive is generally set to 5-30.

高通L1 (Hz)
0.2

- High pass L1 is generally set to 0.2.

2. Top of the sorting software interface

```
探头 BLN=227 ErrX=3 ErrY=5
Continue | 90° Testing
探头 BLN=269 ErrX=19 ErrY=10
Synchro | 90° Stop
```

probe BLN: probe index, the index value of the reaction probe, the normal index is 100-2200, the frequency and the driving parameters of the probe are adjusted, and the

probe index will also change with it.

Continue: (continuous mode): manual detection when using, convenient point-like graphics distribution, with the balance function of the use of keys.

Synchro: (synchronization mode): external I/O synchronization contacts, through the button or PLC trigger synchronization, starting point pattern distribution automatically saved.

Testing (detection)/ Stop (stop): software runs and stops switching.

3. Right side of the sorting software interface



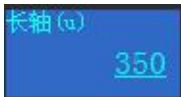

Alarm parameters: The ellipse in the impedance diagram (circle when the long axis and the short axis are equal) is called the alarm zone. In detection, when the signal beyond the range contained in the alarm area detection, the meter at the same time output an alarm signal, that is, judged as unqualified. The shape, size and angle of the alarm area are set according to the actual detection situation. usually use the same specimen with known defects as the tested object to calibrate. The principle of calibration is that the normal workpiece does not exceed the alarm area, and the defective workpiece reliable alarm shall prevail.

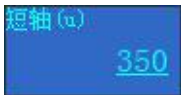
■ Blue Area

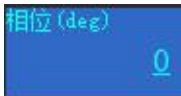

1)  long axis (u): the long diameter of the blue alarm zone ellipse (circle when the long axis and short axis are equal) in the impedance diagram.

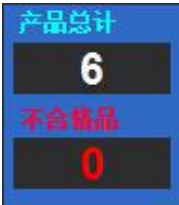
2)  short axis (u): the short diameter of the blue alarm zone ellipse (circle when the long axis and short axis are equal) in the impedance diagram.

3)  phase (deg): angle of the long axis of the ellipse in the alarm zone in the impedance diagram. (360 degrees adjustable)

- : Detect data viewing.
-  Graphic adjustment function. (Open the function after the software, pop-up window below the software)
-  Advanced settings, open after the software interface "magnifying glass adjustment function"
-  Display in sync mode, after sync trigger, display product total and nonconforming product.
-  Eddy current detection software exit key, online (offline) detection end off the software.

4. Sorting software interface

- 
 1.  Origin: The qualified workpiece is calibrated when placed between two contrast probes.
 2.  Delete: Delete the current graphic point.

3.  Calibration: Use in manual mode, when the workpiece is placed in the probe for positioning, click use.

4.  Calibration display: whether the calibration graphics are displayed (no graphics display after calibration click the key)

➤ Steps for testing instruments:

- (1) Turn on the power of the display, turn on the computer, and wait to enter the test screen;
- (2) Preheat for 5 minutes;
- (3) To observe the right side of the interface, it must be T esting(detection mode) state to work properly.

After opening the software, select the right side of the interface to pop up the

adjustment interface. 

- (5) Prepare qualified workpieces (8-10 in quantity) and unqualified workpieces for validation.

(b) Under continue mode (Continue):

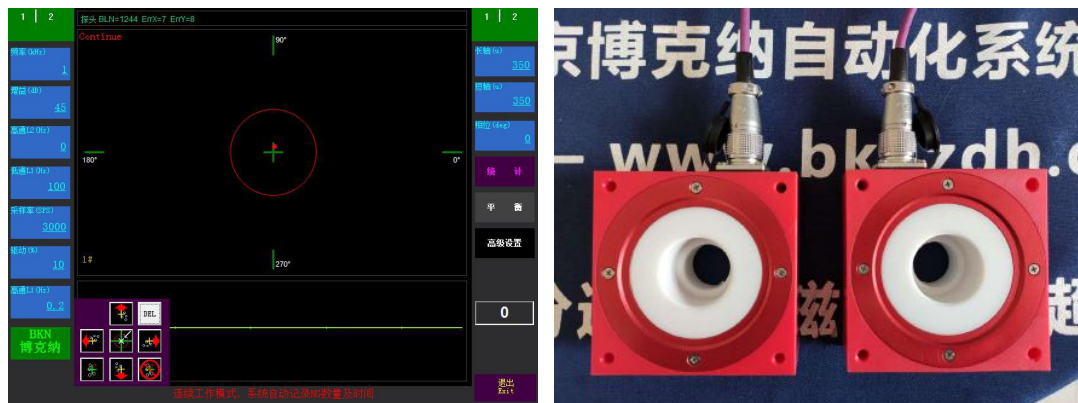

(1) Put two of the qualified workpieces into two contrast probes (A and B), keep the position consistent, press the balance function center point, observe whether

the red dot figure is near the center. 

(1) A probe and the workpiece in the probe as a contrast reference, place one side. B the workpiece in the probe placed on one side of the detection process for use.



(2) Take out the sample in the B probe, put into other qualified workpiece, observe the red dot figure in the interface, can save the figure in the interface according to the calibration, at this time observe the graphic distribution of qualified workpiece to adjust the range of alarm area as follows:



(3) At this time put unqualified workpiece, observe the distribution of red dot pattern, adjust the alarm area range again (the figure of qualified workpiece is within the alarm range, the figure of unqualified workpiece is outside the alarm range, at the same time ensure that the difference between qualified and unqualified figure is large) as shown below.

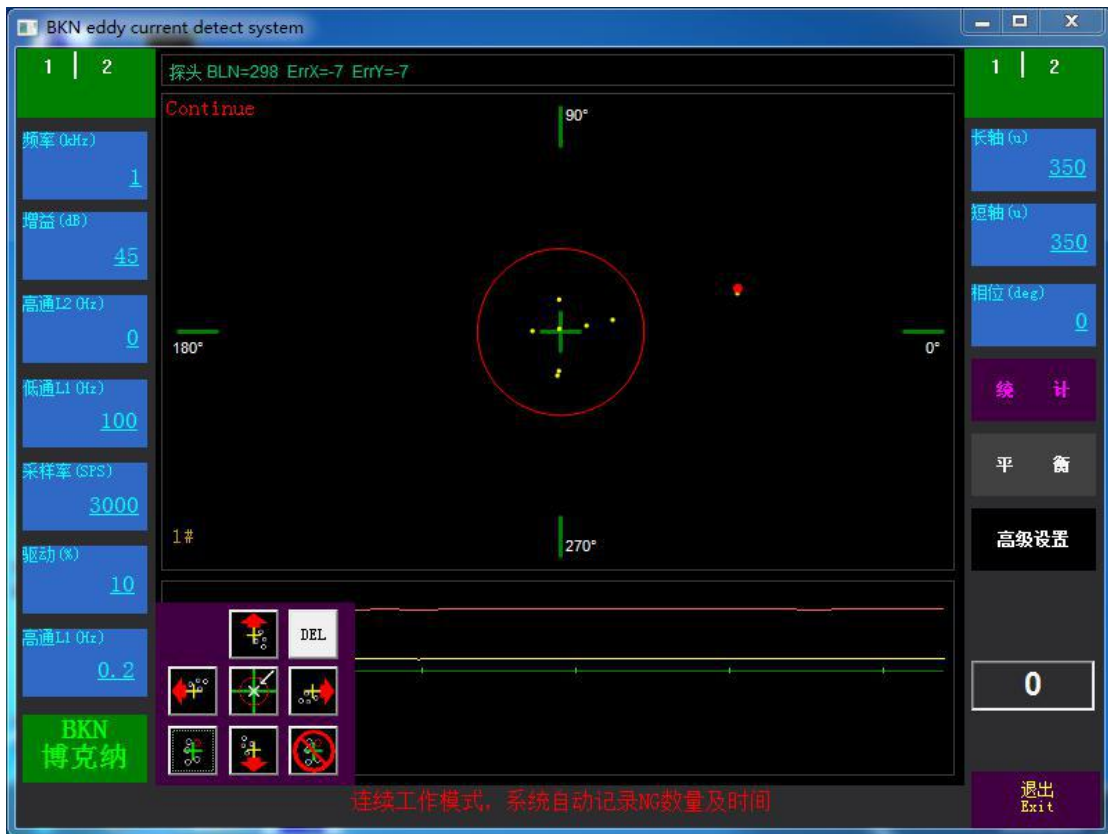

(4) After the adjustment is completed, the batch detection can be carried out, the alarm ring is qualified, and the alarm ring outside is an unqualified instrument alarm

Note: A probe and the workpiece in the probe can not touch or change the position when comparing the reference detection, B probe to place the workpiece and wait for 1-2 seconds, after the red dot figure is stable to confirm the qualified or not qualified to remove the workpiece,

In manual mode, the first workpiece of the original calibration is put into the re-calibration test every 30 minutes to 60 minutes.

During synchronization mode (Synchro):

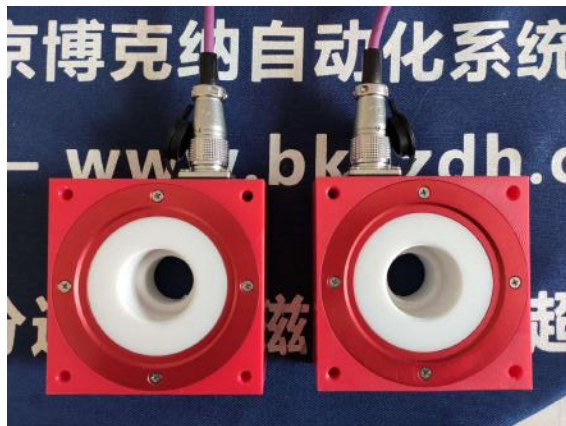
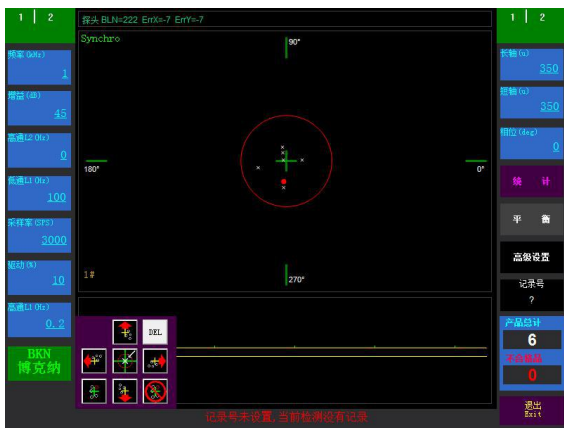

(2) Take out two of the qualified workpieces and put them into two contrast probes

(A and B) respectively, the position is consistent, press the balance function



central point, observe whether the red dot figure is near the center.

(3) Trigger synchronization signal 1 second off (two switch or PLC control) at this point in the interface display white dot graphics.

(4) A probe and the workpiece in the probe as the contrast reference, place one side, and place the workpiece in the B probe on one side during the inspection process.

(5) Take out the sample in the B probe, put into other qualified workpiece, stay for 1 second after each placement, then trigger the synchronous signal, observe the graphic distribution of the qualified workpiece, adjust the range of alarm area as follows:



(6) At this time into the unqualified workpiece, trigger synchronization signal, at this time outside the alarm ring graphics for blue dot figure, again adjust the alarm area range (qualified workpiece graphics in the alarm range, unqualified workpiece graphics outside the alarm range, while ensuring that the difference between qualified and unqualified graphics is large) as shown below.



(7) After the adjustment is completed, it can be detected in batches, the alarm ring is qualified (white dot figure), and the alarm ring outside is unqualified (blue dot figure) instrument alarm.

Note: A probe and the workpiece in the probe can not touch or change the position when comparing the reference detection, B probe to place the workpiece and wait for 1-2 seconds, after the red dot figure is stable to confirm the qualified or not qualified to remove the workpiece,
In manual mode, the first workpiece of the original calibration is put into the re-calibration test every 30 minutes to 60 minutes.

Figure (2)

➤ Hardness sorting external I/O wiring method:

+24 V----- External power +24 V

0V-----0V external power supply

Synchronization ----- Sorting detection trigger synchronization

signal (low level input)

Alarm ---- Sorting detection NG signal (low level output)

Please consult the relevant technical personnel before connecting line!

The user must check whether the line is wrong after connecting, if the relay is switched, pay attention to the relay do not pull down, must have a load to turn on the instrument switch.

➤ Quick hardness sorting common problems and troubleshooting

methods:

I. high pass L1(hz) regulation: there are "0.2""0.3"2 parameters. (All available)

set the value to 0.2: universal parameter.

Set the value to 0.3: After opening the instrument and software, press "origin" first, then the instrument preheat

Set high pass L1 to 0.3 after 5 minutes and put it directly into OK work

Part calibration.

2. Counting issues

(1) The total number of counts and the number of non-conformity in synchronous mode, after the workpiece is put into the probe for 1-2 seconds, the synchronous signal count is triggered. No quantity display in continuous mode.

3. Open the software and select the right side of the interface pop-up



adjustment interface as follows:

4. No graphical display for interface detection

- (1) Check the instrument probe line and I/O line for loosening.
- (2) check computer IP and instrument IP "192.168.1.2" to be consistent.
- (3) Does the top left position in the middle of the software interface show "probe BLN=XXX".?